

Analog Devices Welcomes Hittite Microwave Corporation

NO CONTENT ON THE ATTACHED DOCUMENT HAS CHANGED



THIS PAGE INTENTIONALLY LEFT BLANK



Typical Applications

This HMC903 is ideal for:

- Point-to-Point Radios
- Point-to-Multi-Point Radios
- Military & Space
- Test Instrumentation

Features

- Low Noise Figure: 1.6 dB
- High Gain: 19 dB
- P1dB Output Power: 16 dBm
- Single Supply Voltage: +3.5 V @ 90 mA
- Output IP3: 27 dBm
- 50 Ohm matched Input/Output
- Die Size: 1.33 x 1.08 x 0.1 mm

Functional Diagram

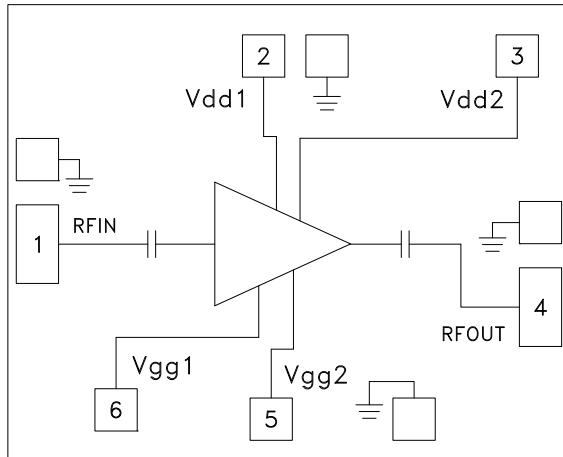

General Description

The HMC903 is a self-biased GaAs MMIC Low Noise Amplifier which operates between 6 and 18 GHz. This LNA provides 19 dB of small signal gain, 1.6 dB noise figure, and output IP3 of 27 dBm, while requiring only 90 mA from a +3.5 V supply. The P1dB output power of 16 dBm enables the LNA to function as a LO driver for balanced, I/Q or image reject mixers. The HMC903 also features I/Os that are DC blocked and internally matched to 50 Ohms for ease of integration into multi-chip-modules (MCMs). All data is taken with the chip in a 50 Ohm test fixture connected via 0.025 mm (1 mil) diameter with bonds of 0.31 mm (12 mils) length.

Electrical Specifications, $T_A = +25^\circ\text{C}$, $V_{dd1} = V_{dd2} = +3.5\text{V}$, $I_{dd} = 90\text{mA}$ [1]

Parameter	Min.	Typ.	Max.	Units
Frequency Range	6 - 18			GHz
Gain	17	19		dB
Gain Variation over Temperature		0.013		dB / °C
Noise Figure		1.6	2.1	dB
Input Return Loss		11		dB
Output Return Loss		13		dB
Output Power for 1 dB Compression		16		dBm
Saturated Output Power (P _{sat})		18		dBm
Output Third Order Intercept (IP3)		27		dBm
Supply Current (I _{dd}) (V _{dd} = 3.5V, V _{gg1} = V _{gg2} = Open)		90		mA

[1] V_{gg1} = V_{gg2} = Open for normal, self-biased operation



Broadband Gain & Return Loss [1]

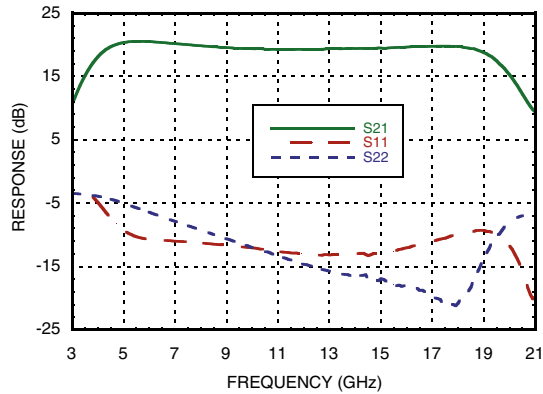

Gain vs. Temperature

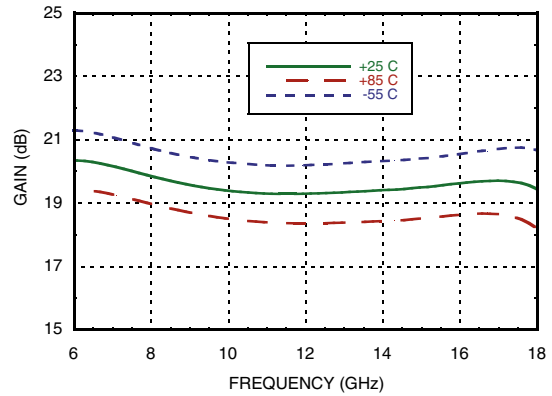

Input Return Loss vs. Temperature

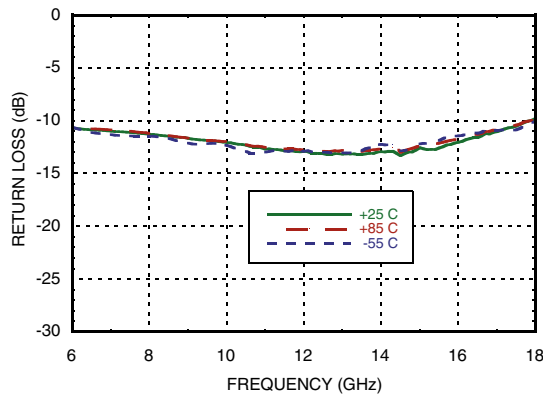

Output Return Loss vs. Temperature

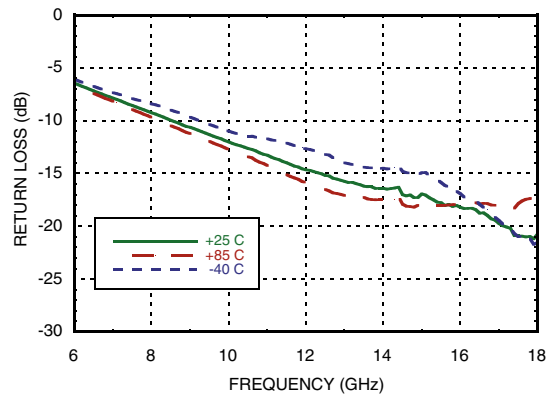

Noise Figure vs. Temperature

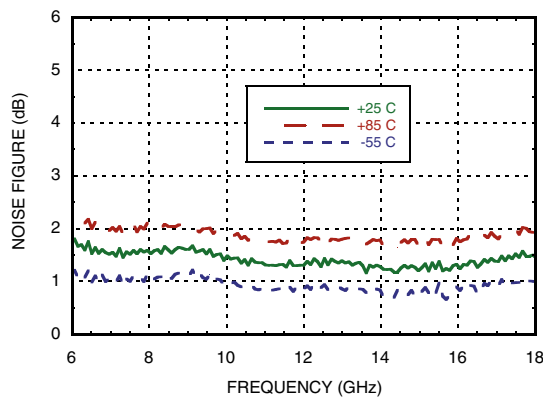

Output IP3 vs. Temperature

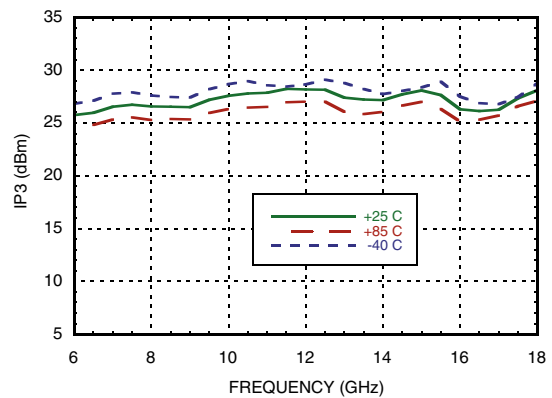



P1dB vs. Temperature

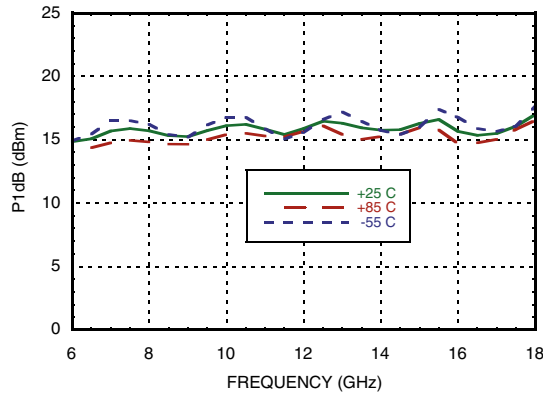

Psat vs. Temperature

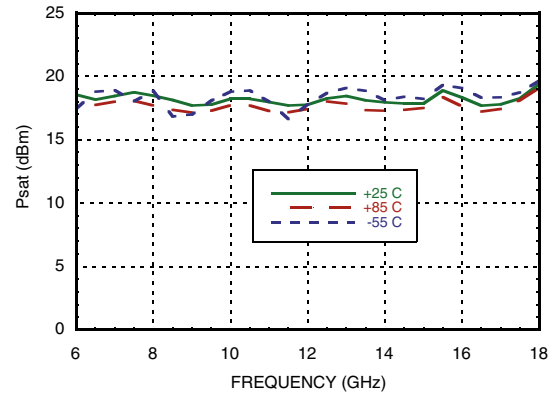

Reverse Isolation vs. Temperature

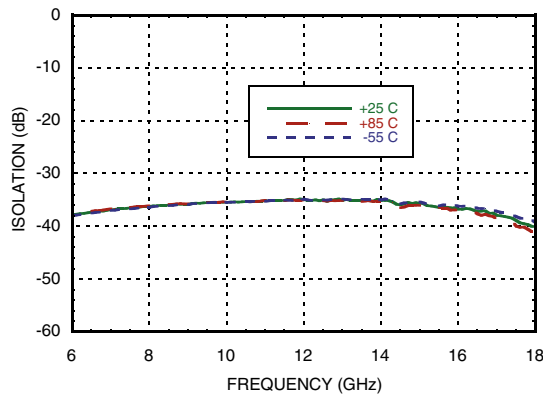

Power Compression @ 12 GHz

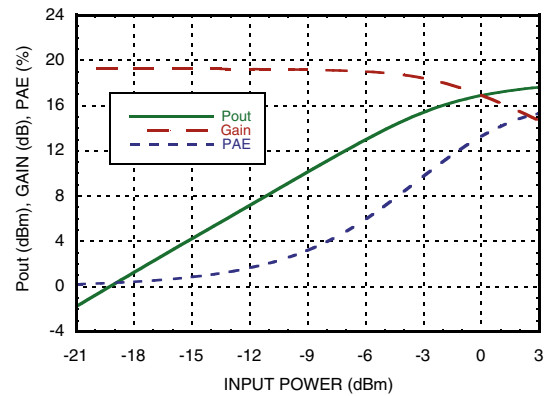

Gain, Noise Figure & Power vs. Supply Voltage @ 12 GHz

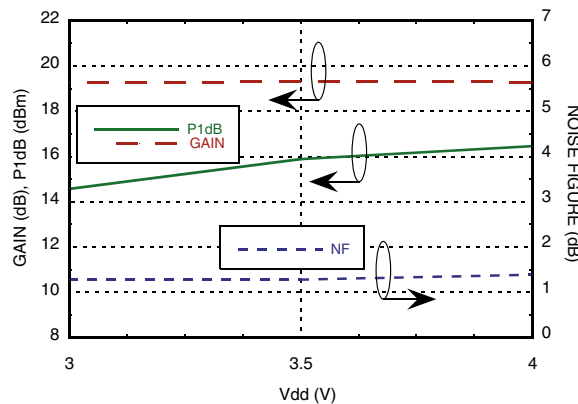



**GaAs pHEMT MMIC LOW NOISE AMPLIFIER
6 - 18 GHz**

Absolute Maximum Ratings

Drain Bias Voltage	+4.5V
RF Input Power	+10 dBm
Gate Bias Voltage, V _{gg1}	-0.8V to +0.2V
Gate Bias Voltage, V _{gg2}	-0.8V to +0.2V
Channel Temperature	175 °C
Continuous P _{diss} (T = 85 °C) (derate 6.9 mW/°C above 85 °C)	0.62 W
Thermal Resistance (Channel to die bottom)	144.8 °C/W
Storage Temperature	-65 to +150 °C
Operating Temperature	-55 to +85 °C
ESD Sensitivity (HBM)	Class 0, Passed 150V



**ELECTROSTATIC SENSITIVE DEVICE
OBSERVE HANDLING PRECAUTIONS**

Outline Drawing

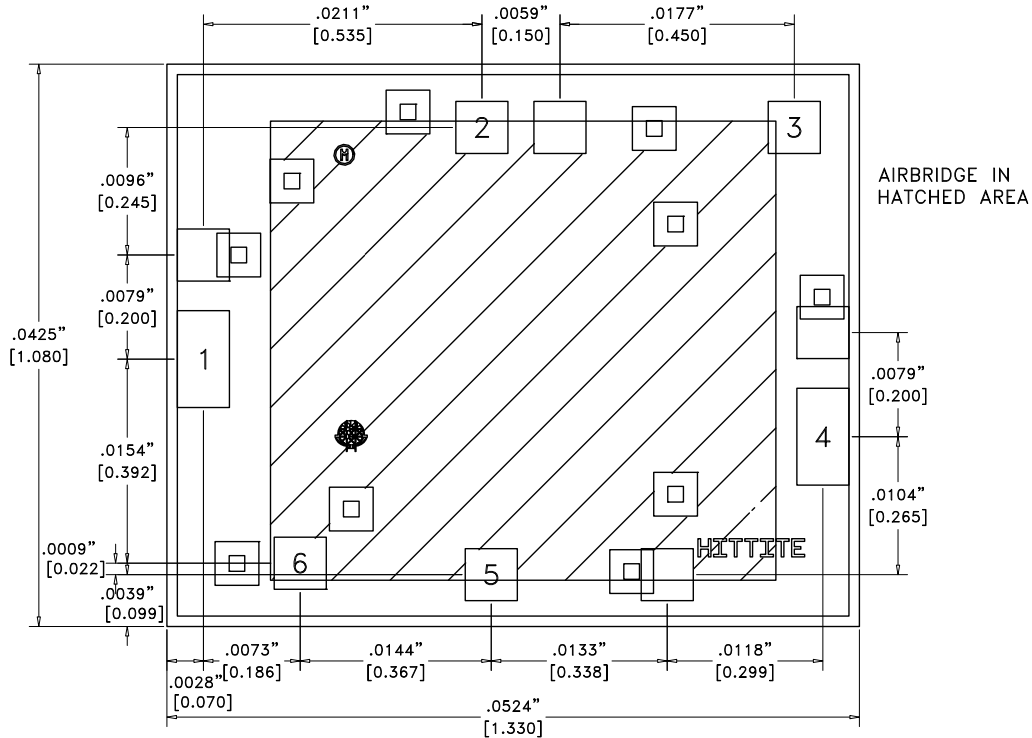

This die utilizes fragile air bridges. Any pick-up tools used must not contact the die in the cross hatched area.

Die Packaging Information [1]

Standard	Alternate
GP-2 (Gel Pack)	[2]

[1] Refer to the "Packaging Information" section for die packaging dimensions.

[2] For alternate packaging information contact Hittite Microwave Corporation.

NOTES:

1. ALL DIMENSIONS IN INCHES [MILLIMETERS]
2. DIE THICKNESS IS 0.004 (0.100)
3. TYPICAL BOND PAD IS 0.004 (0.100) SQUARE
4. BOND PAD METALLIZATION: GOLD
5. BACKSIDE METALLIZATION: GOLD
6. BACKSIDE METAL IS GROUND
7. NO CONNECTION REQUIRED FOR UNLABELED BOND PADS
8. OVERALL DIE SIZE IS ±.002



GaAs pHEMT MMIC LOW NOISE AMPLIFIER
6 - 18 GHz

Pad Descriptions

Pad Number	Function	Description	Interface Schematic
1	RFIN	This pin is AC coupled and matched to 50 Ohms	
2, 3	Vdd1, Vdd2	Power supply voltage for the amplifier see assembly for required external components.	
4	RFOUT	This pin is AC coupled and matched to 50 Ohms	
5, 6	Vgg2, Vgg1	Optional gate control for amplifier. If left open, the amplifier will run at standard current. Negative voltage applied will reduce current.	
Die Bottom	GND	Die bottom must be connected to RF/DC ground.	

Assembly Diagram

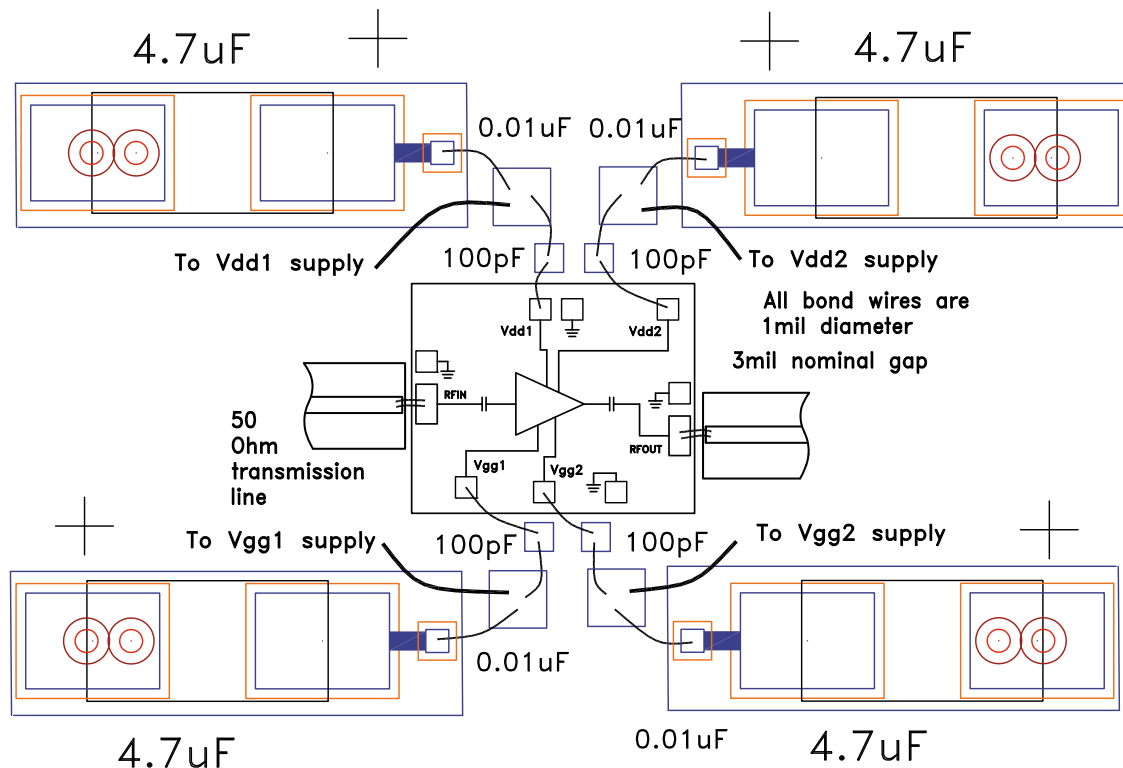



GaAs pHEMT MMIC LOW NOISE AMPLIFIER
6 - 18 GHz

Mounting & Bonding Techniques for Millimeterwave GaAs MMICs

The die should be attached directly to the ground plane eutectically or with conductive epoxy (see HMC general Handling, Mounting, Bonding Note).

50 Ohm Microstrip transmission lines on 0.127mm (5 mil) thick alumina thin film substrates are recommended for bringing RF to and from the chip (Figure 1). If 0.254mm (10 mil) thick alumina thin film substrates must be used, the die should be raised 0.150mm (6 mils) so that the surface of the die is coplanar with the surface of the substrate. One way to accomplish this is to attach the 0.102mm (4 mil) thick die to a 0.150mm (6 mil) thick molybdenum heat spreader (moly-tab) which is then attached to the ground plane (Figure 2).

Microstrip substrates should be placed as close to the die as possible in order to minimize bond wire length. Typical die-to-substrate spacing is 0.076mm to 0.152 mm (3 to 6 mils).

Handling Precautions

Follow these precautions to avoid permanent damage.

Storage: All bare die are placed in either Waffle or Gel based ESD protective containers, and then sealed in an ESD protective bag for shipment. Once the sealed ESD protective bag has been opened, all die should be stored in a dry nitrogen environment.

Cleanliness: Handle the chips in a clean environment. DO NOT attempt to clean the chip using liquid cleaning systems.

Static Sensitivity: Follow ESD precautions to protect against ESD strikes.

Transients: Suppress instrument and bias supply transients while bias is applied. Use shielded signal and bias cables to minimize inductive pick-up.

General Handling: Handle the chip along the edges with a vacuum collet or with a sharp pair of bent tweezers. The surface of the chip has fragile air bridges and should not be touched with vacuum collet, tweezers, or fingers.

Mounting

The chip is back-metallized and can be die mounted with AuSn eutectic preforms or with electrically conductive epoxy. The mounting surface should be clean and flat.

Eutectic Die Attach: A 80/20 gold tin preform is recommended with a work surface temperature of 255 °C and a tool temperature of 265 °C. When hot 90/10 nitrogen/hydrogen gas is applied, tool tip temperature should be 290 °C. DO NOT expose the chip to a temperature greater than 320 °C for more than 20 seconds. No more than 3 seconds of scrubbing should be required for attachment.

Epoxy Die Attach: Apply a minimum amount of epoxy to the mounting surface so that a thin epoxy fillet is observed around the perimeter of the chip once it is placed into position. Cure epoxy per the manufacturer's schedule.

Wire Bonding

RF bonds made with two 1 mil wires are recommended. These bonds should be thermosonically bonded with a force of 40-60 grams. DC bonds of 0.001" (0.025 mm) diameter, thermosonically bonded, are recommended. Ball bonds should be made with a force of 40-50 grams and wedge bonds at 18-22 grams. All bonds should be made with a nominal stage temperature of 150 °C. A minimum amount of ultrasonic energy should be applied to achieve reliable bonds. All bonds should be as short as possible, less than 12 mils (0.31 mm).

